

# Digital Indicating Controller LT35A/37A SERIES



LT 35A/37A series is digital indicating controller with indicating accuracy of  $\pm 0.2\%$  and the control cycle of approximately 0.3 seconds.

3 types of auto tuning functions and overshoot suppression functions achieve superior control stability. Combination of internal computing function and enriched input and output option support various usage scenarios.

Special loader software provides ease of setting operations and data acquisition.

## FEATURES

### Compact design

Short depth of instrument (case 65mm) saves the space of instrument and control board.

### Universal input

Input types is user-changeable from among thermocouple, resistance thermometer, DC voltage and DC current.

### Outstanding controllability

Control system can be selected from two-position control and PID control.

It has overshoot suppression function and high-functional PID.

### 3 type of auto tuning

Can be selected from normal, rapid-response, stable tuning on the control target.

### Various input / output signal (optional) are available

Current transformer input 2 points, event output 3 points (Max), remote signal input 4 points, communication interface (RS485).

### Conformance to international safety standards

CE marking, RoHS

### Loader software is available

Various parameter settings and data acquisition can be done easily using loader software (sold separately).

## PARTS NAMES OF FUNCTIONS

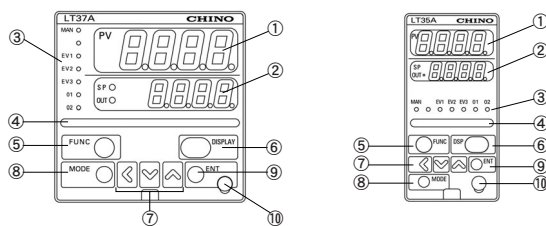

- ① Upper display : Displays PV values (measuring temperature, etc.) or setting items.
- ② Lower display : Displays SP values (preset temperature, etc.) and other parameter set values.
- ③ Status display lamp : MAN : Lights when MANUAL (manual mode)  
EV1 to EV3 : Lights when event outputs are ON.  
O1 to O2 : Lights when the control output is ON.
- ④ Multiple functions indicating lamp : User-settable max. 3 sets combination of condition and status as preferred functions (alarm, READY, etc.).
- ⑤ [FUNC] key : Press 1 second or longer, then enters frequently used functions and operations set in advance. The function is disabled at factory default.
- ⑥ [DISPLAY]/[DSP] key : Switch display in operation mode. Or back to operation mode from parameter setting mode.
- ⑦ [MODE] key : Switches the display.
- ⑧ <, V, ^ Key : Used for incrementing numeric values and performing arithmetic shift operation.
- ⑨ [ENT] key : Starts to change settings and set value
- ⑩ Loader connector : Connects to a personal computer by using USB loader cable.



## MODELS

LT35A□□□□□□□□□□/LT37A□□□□□□□□□□

	Measur- ing input	Control output	I/O option	Terminal type	Power	Extra	Specifications
LT35A							48mmX96mm front size
LT37A							96mmX96mm front size
0							Universal input
							Control output 1   Control output 2
1	0						ON-OFF pulse output   —
5	0						SSR drive pulse output   —
5	3						SSR drive pulse output   Current output
5	5						SSR drive pulse output   SSR drive pulse output
3	0						Current output   —
3	3						Current output   Current output
*4	1						Event output: 3 points
	2						Event output 3 points, Transmission signal output (current output)
*2,*4	4						Event output 2 points (independent contact)
*2	5						Event output 2 points (independent contact), Transmission signal output (current output)
	0						—
*1	1						Current transformer input 2 points External signal input: 4 points
*1	2						Current transformer input 2 points External signal input: 4 points Communication interface RS485
	0						Terminal block type
	A						100 to 240 V AC
	D						24V AC/DC
	00						No additional treatment
	Y0						Complying with the traceability certificate
*3	T0						Tropical treatment
*3	K0						Sulfur resistance treatment

\*1: Current transformer is sold separately.

\*2: 24V AC/DC power supply can not be selected.

\*3: Non-conforming to CE, UL/cUL.

\*4: Event output are 2 types, specify models of 3 point (common) or 2 points (independent).

**Compact size**



There are size 48x96mm and 96x96mm available. Depth is only 65mm, so it is space saving for any installation.

**Correspond to heat / cool control**

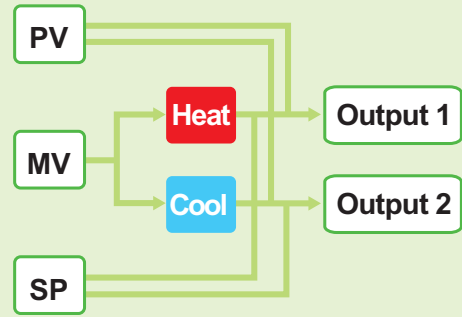

Control output of heat or cool can be assigned to the output 1 and 2. PV and SP can also be assigned and used as transmission signal output.

**Advanced controllability**

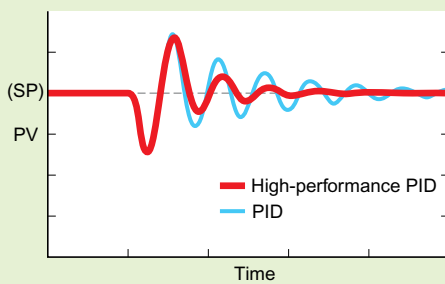

In addition to the conventional PID, "High-performance PID" is available which has unique algorithm aim to converge hunting quickly to decrease settling time.

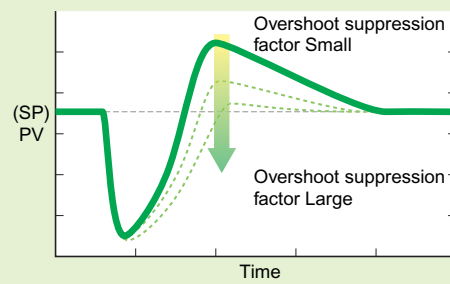

By "Overshoot suppression function" which controls overshoot at SP changing and/or disturbance response, the control has been able to develop stronger resistance for disturbance and superior stability.

**Easy-to-read display** On the display, measuring value (PV) is indicated in green and setting value (SP) is indicated in orange LEDs.

**Frequently used operation can be assigned to the FUNC key**

By assigning frequently used operation such as Auto/Manual and RUN/READY to the FUNC key, only one press of a button enables switching the functions.

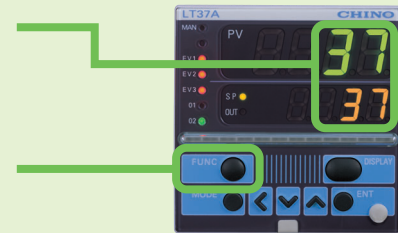

**Various combinations of input and output**



\*Various parameter settings are available from PC by using dedicated loader software. However, it requires dedicated loader cable (sold separately).

**Loader software (sold separately)**

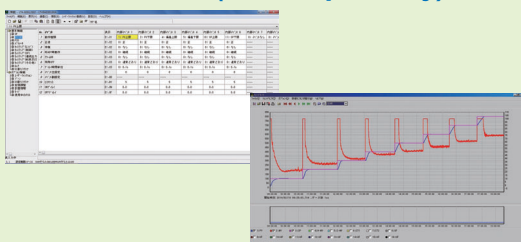

Various parameter settings and data acquisition are available by connecting this controller to the PC which the loader software is installed.

**Internal event can be output as external digital (contact) output by logical operation.**

On LT37A...

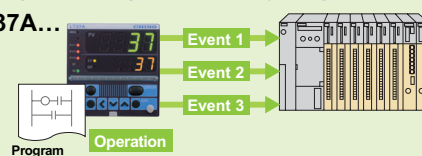

3 points of event can be output

Result of the logical operation which performed on selected five points of various internal events is able to be assigned to the three points of external digital outputs. It can simplify process of event outputs which logical operation was conventionally performed on receiver side.

## SPECIFICATIONS

### Input specifications

Input signal: Universal input (Thermocouple, Resistance Thermometer, DC voltage/current)  
 Range type: Refer to a measuring range table  
 Input sampling cycle: 300ms  
 Accuracy rating:  $\pm 0.2\%FS \pm 1$  digit  
 Reference junction compensation accuracy:  $\pm 0.5^\circ C$  (at ambient temperature  $23^\circ C \pm 2^\circ C$ )

### Control specifications

Output type: ON-OFF pulse output type 1c 250V AC/ 30V DC 3A (resistance load)  
 Current output type 0 to 20mA DC, 4 to 20 mA DC (It can be changed by the setting)  
 SSR drive pulse output type 19V DC $\pm 15\%$ , Internal resistance 82 $\Omega$ , Allowable current Max. 24mA DC

### Event output

Output point: Max. 3 points  
 Contact capacity: 250V AC/ 30V DC 2A (resistance load)  
 Output type: Relay output 1a  
 Type: Absolute value, deviation, loop diagnosis, timer, heater disconnection and etc. Total 30 types  
 \*Event output is a standard feature.

### General specifications

Ambient temperature range: 0 to 50 $^\circ C$   
 Power supply voltage range: AC power supply: 100 to 240 V AC, 50/60Hz

DC power supply: 24 V AC, 50/60Hz/24V DC  
 AC power supply: 12 VA and/or lower  
 DC power supply: 12 VA and/or lower (24V AC) 8W and/or lower (24V DC)  
 Safety standards: CE marking compliant product  
 Weight: LT35A 250g, LT37A 300g

## OPTION

External signal input Input point: 4 points  
 Function: AUTO/MANUAL, RUN/READY, SV, Timer Stop/Start and etc. Total 17 functions  
 Transmission signal output Output type: 0 to 20mA DC or 4 to 20mA DC current output  
 Allowable load resistance: 600 $\Omega$  and/or lower  
 Output accuracy:  $\pm 0.2\% FS$  (at ambient temperature  $23^\circ C \pm 2^\circ C$ ), however, 0 to 1mA is at  $\pm 1\% FS$   
 Current transformer input (CT) Input point: 2 points  
 CT sold separately:  $\varnothing 5.8$  (LTA-P207),  $\varnothing 12$  (LTA-P208)  
 Measuring current: 0.4 to 50.0A  
 Display accuracy:  $\pm 5\% FS$   
 Communication interface Communication type: RS485  
 Connection unit: Max. 31 units  
 Communication speed: Max. 38,400bps  
 Communication protocol: MODBUS  
 Terminating resistor: Connection prohibited

## MEASURING RANGE

Input type	C01 Set value	Measuring range	Accuracy
Thermocouple	1	-200 to 1200 $^\circ C$	$\pm 0.2\%FS \pm 1$ digit Minus area is $\pm 0.4\%FS \pm 1$ digit Under 260 $^\circ C$ : $\pm 4.0\%FS$ , 260-800 $^\circ C$ : $\pm 0.4\%FS$
	2	0 to 1200 $^\circ C$	
	3	0.0 to 800.0 $^\circ C$	
	4	0.0 to 600.0 $^\circ C$	
	5	0.0 to 400.0 $^\circ C$	
	6	-200.0 to 400.0 $^\circ C$	
	7	-200.0 to 200.0 $^\circ C$	
	8	0 to 1200 $^\circ C$	
	9	0.0 to 800.0 $^\circ C$	
	10	0.0 to 600.0 $^\circ C$	
	11	-200.0 to 400.0 $^\circ C$	
	12	0.0 to 800.0 $^\circ C$	
	13	0.0 to 600.0 $^\circ C$	
	14	-200.0 to 400.0 $^\circ C$	
	15	0 to 1600 $^\circ C$	
	16	0 to 1600 $^\circ C$	
	17	0 to 1800 $^\circ C$	
	18	0 to 1300 $^\circ C$	
	19	0 to 1300 $^\circ C$	
RTD	20	0 to 1400 $^\circ C$	$\pm 0.2\%FS \pm 1$ digit, Minus area is $\pm 0.4\%FS \pm 1$ digit 0~300 $^\circ C$ : $\pm 2.5\%FS$ , 300 to 800 $^\circ C$ : $\pm 1.5\%FS$ , 800 to 1900 $^\circ C$ : $\pm 0.5\%FS$ $\pm 0.2\%FS \pm 1$ digit, Minus area is $\pm 0.4\%FS \pm 1$ digit $\pm 1.5K$
	21	0 to 2300 $^\circ C$	
	22	0 to 1300 $^\circ C$	
	23	0 to 1900 $^\circ C$	
	24	-200.0 to 400.0 $^\circ C$	
	25	-100.0 to 800.0 $^\circ C$	
	26	0.0 to 360.0K	
	41	-200.0 to 500.0 $^\circ C$	
	42	-200.0 to 500.0 $^\circ C$	
	43	-200.0 to 200.0 $^\circ C$	
	44	-200.0 to 200.0 $^\circ C$	
	45	-100.0 to 300.0 $^\circ C$	
	46	-100.0 to 300.0 $^\circ C$	
	47	-100.0 to 200.0 $^\circ C$	
	48	-100.0 to 200.0 $^\circ C$	
	49	-100.0 to 150.0 $^\circ C$	
	50	-100.0 to 150.0 $^\circ C$	
	51	-50.0 to 200.0 $^\circ C$	
	52	-50.0 to 200.0 $^\circ C$	
	53	-50.0 to 100.0 $^\circ C$	
	54	-50.0 to 100.0 $^\circ C$	
55	-60.0 to 40.0 $^\circ C$		
56	-60.0 to 40.0 $^\circ C$		
57	-40.0 to 60.0 $^\circ C$		
58	-40.0 to 60.0 $^\circ C$		
59	-10.00 to 60.00 $^\circ C$		
60	-10.00 to 60.00 $^\circ C$		
61	0.0 to 100.0 $^\circ C$		
62	0.0 to 100.0 $^\circ C$		
63	0.0 to 200.0 $^\circ C$		
64	0.0 to 200.0 $^\circ C$		
65	0.0 to 300.0 $^\circ C$		
66	0.0 to 300.0 $^\circ C$		
67	0.0 to 500.0 $^\circ C$		
68	0.0 to 500.0 $^\circ C$		
DC voltage/current	81	0 to 10mV	The scaling and decimal point position can be changed variably in a range of -1999 to +9999 $\pm 0.2\%FS \pm 1$ digit
	82	-10 to 10mV	
	83	0 to 100mV	
	84	0 to 1V	
	86	1 to 5V	
	87	0 to 5V	
	88	0 to 10V	
	89	0 to 20mA	
90	4 to 20mA		

\*Lower limit of indication value of B thermocouple is 20 $^\circ C$

### Applicable standards

#### Thermocouple

K, J, E, T, R, S, B, N : JIS C 1602-1995  
 Platinel II : Engelhard Industries(ITS90)  
 WRe5-26 : ASTM E988-96(Reapproved 2002)  
 DIN U, DIN L : DIN43710-1985  
 NiMo : ASTM E1751-00

PR40-20 : Johnson Matthey  
 CR-AuFe : Hayashi Denko

#### Resistance thermometer

Pt100 : JIS C 1604-1997  
 JPt100 : JIS C 1604-1989

## ACCESSORY

Item	Model
Attachment (for terminal block type)	LTA-P307
Manual	L3A-11-□

## OPTIONAL SOFTWARE

Item	Model
Loader software (cable included)	LTA-S001
Loader software	LTA-S002
Loader cable	LTA-S003

## ACCESSORY (Sold separately)

Item	Model
Hard cover	LT35A LTA-P301
	LT37A LTA-P302
Soft cover	LT35A LTA-P303
	LT37A LTA-P304
Terminal cover	LT35A LTA-P305
	LT37A LTA-P306
Current transformer	LTA-P207 (5.8 mm hole dia.) LTA-P208 (12 mm hole dia.)
Attachment	LTA-P307
Shunt resistor 250Ω	EZ-RX250

## TERMINAL BOARD

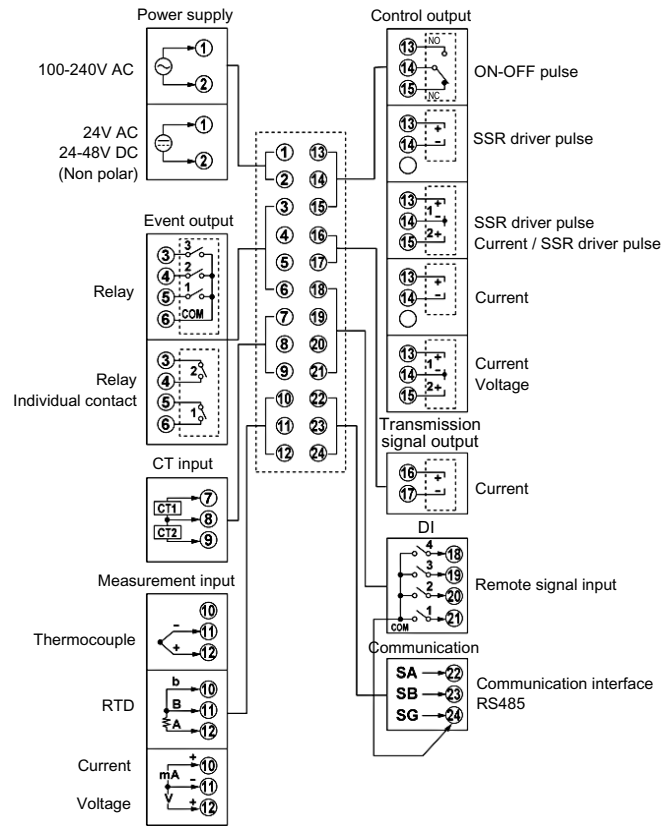

## DIMENSIONS

### LT37A

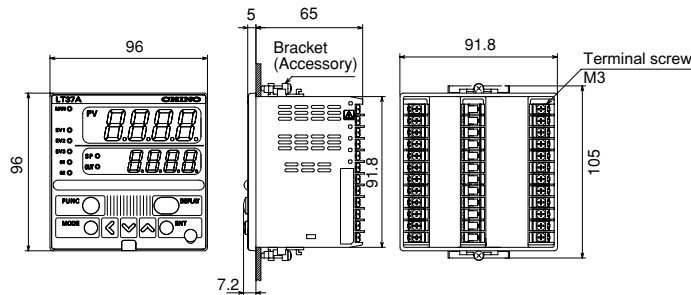

### LT35A

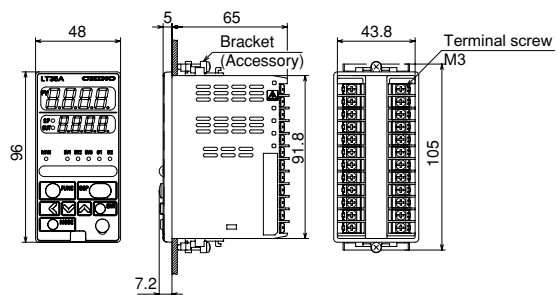

### Panel cutout

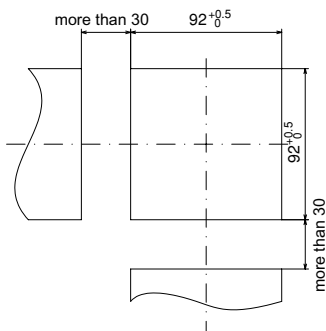

### Minimum clearance for plural installation

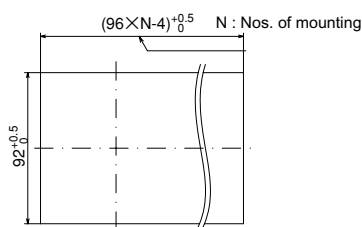

### Panel cutout

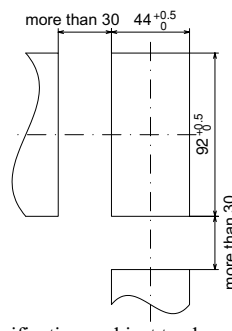

### Minimum clearance for plural installation

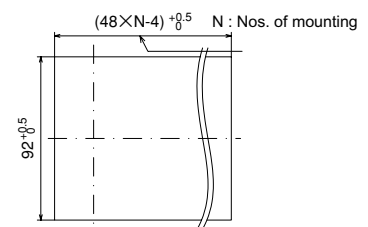

Unit : mm

Specifications subject to change without notice. Printed in Japan (I) 2014. 12

## CHINO CORPORATION

32-8 KUMANO-CHO, ITABASHI-KU, TOKYO 173-8632  
 Telephone : +81-3-3956-2171  
 Facsimile : +81-3-3956-0915  
 E-mail : inter@chino.co.jp  
 Website : www.chino.co.jp/